

ワクワクルはかせ

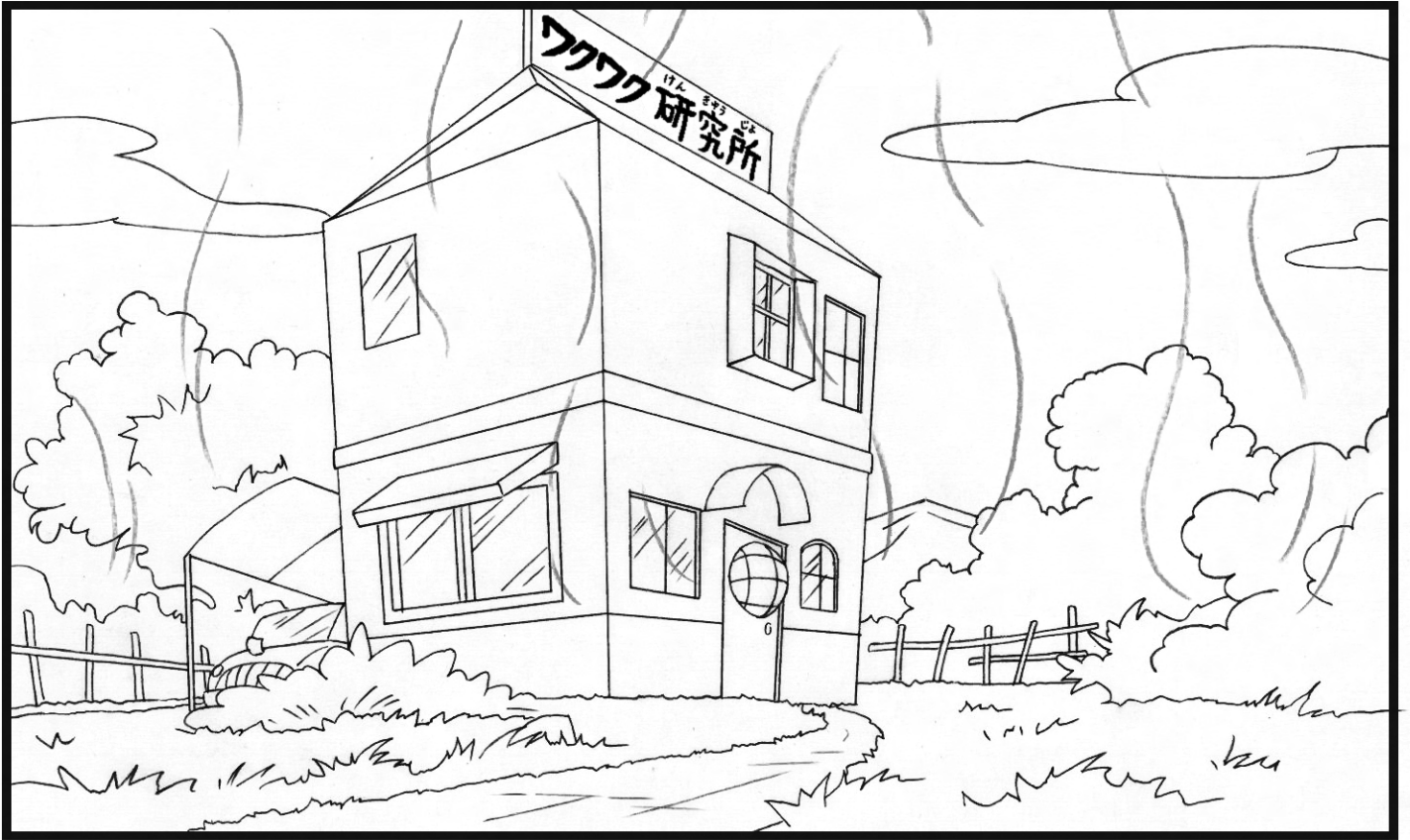

さく
作・イイムラカズオ

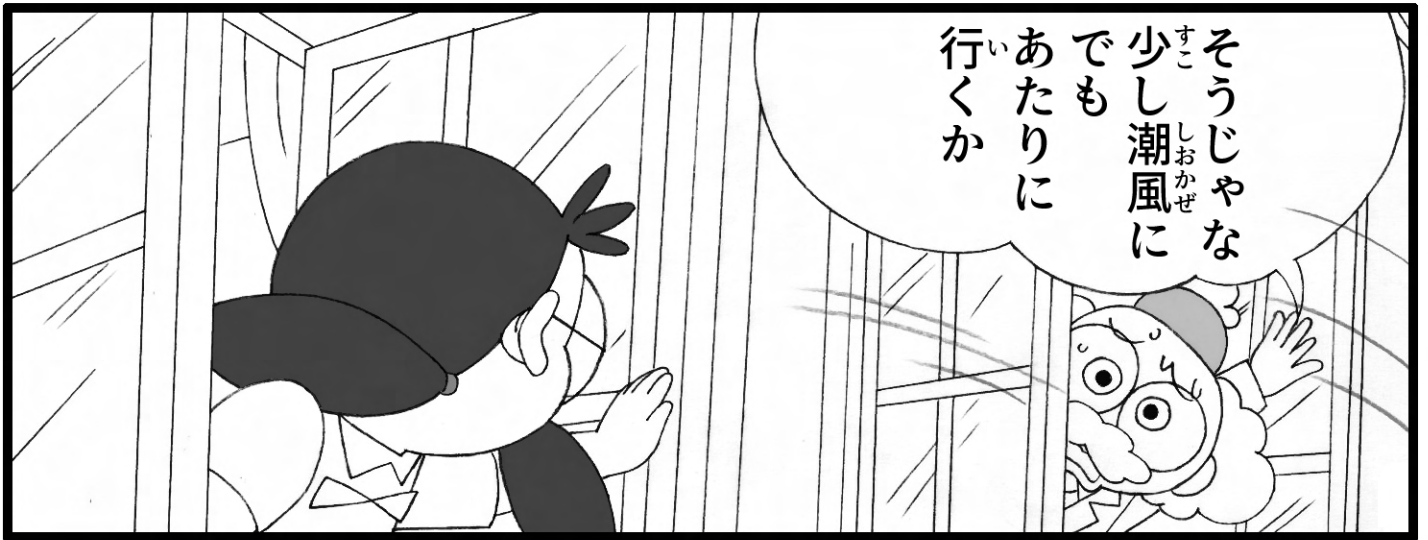

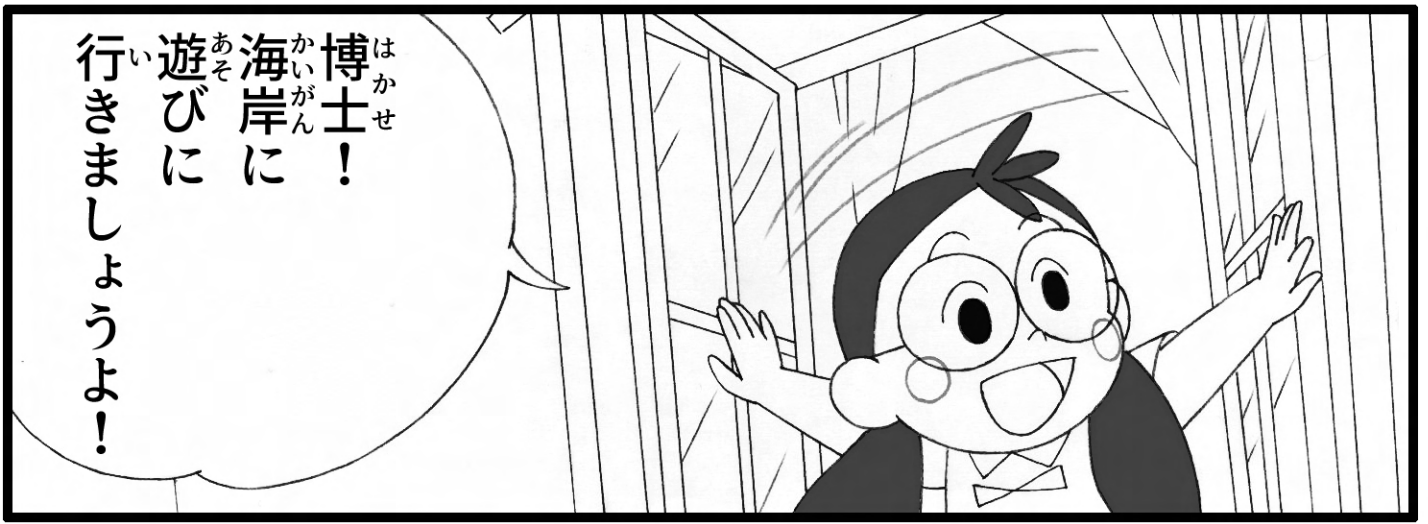

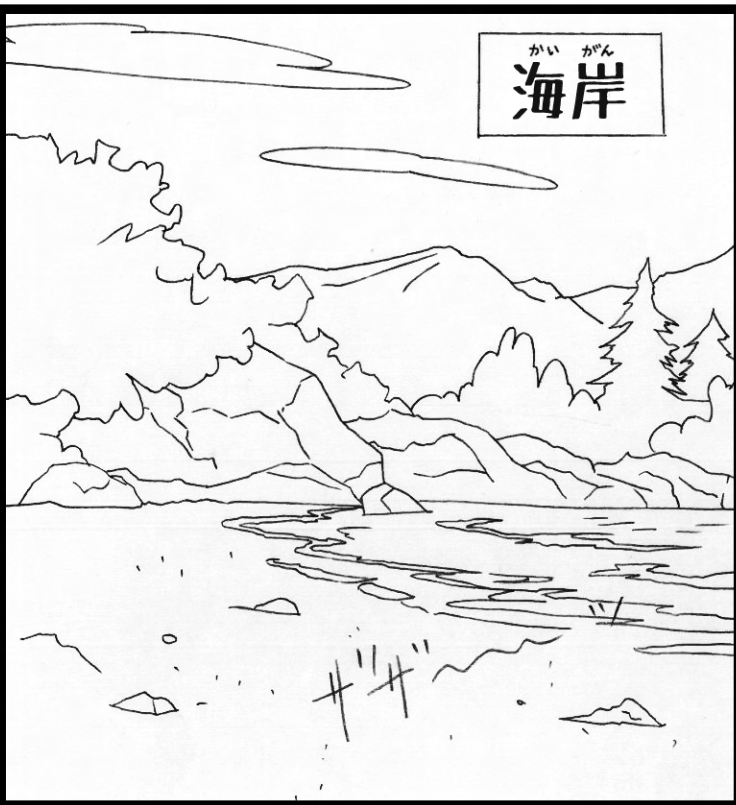

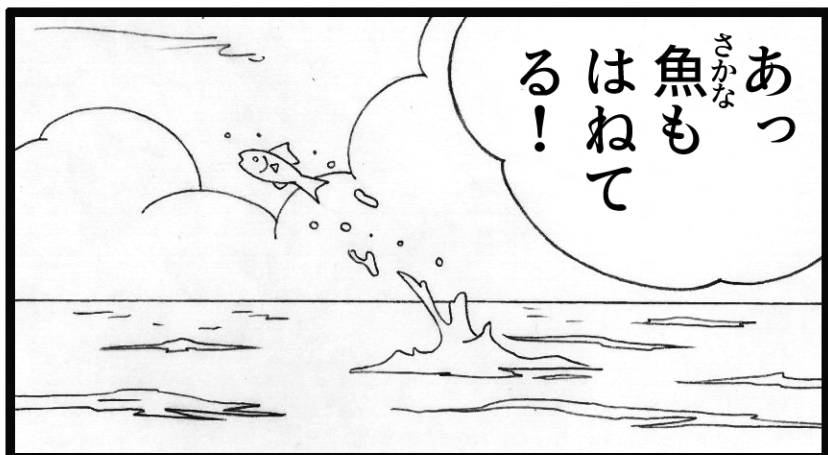
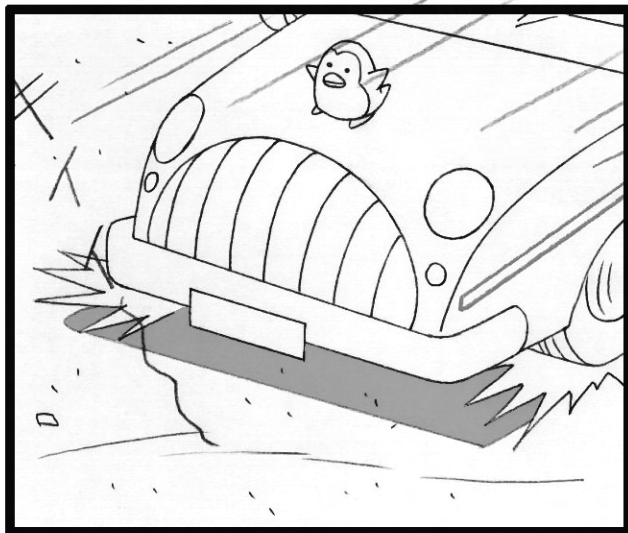
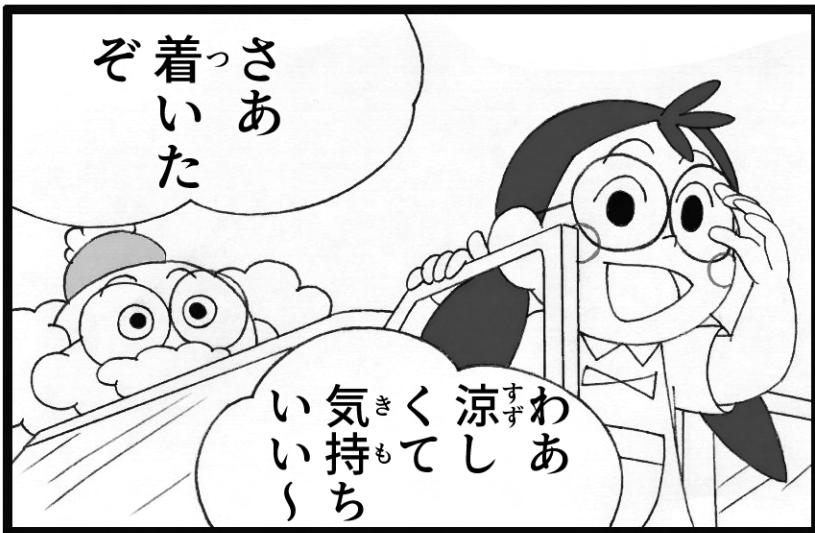

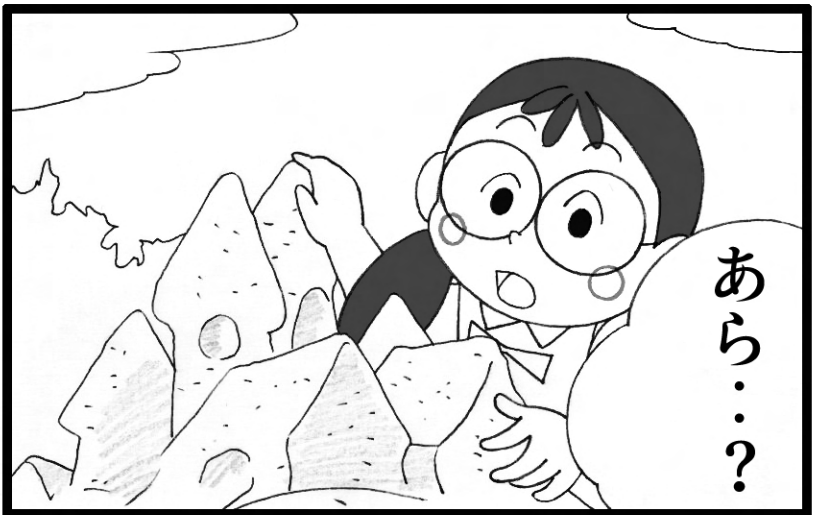
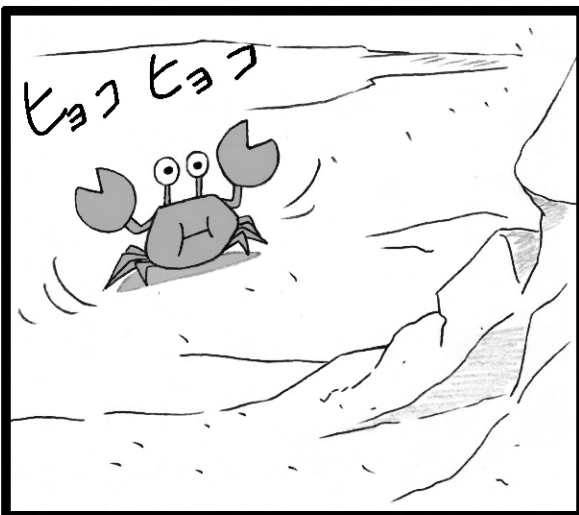
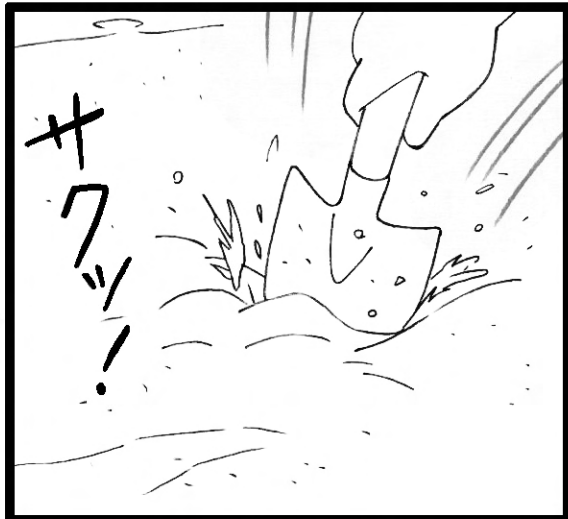

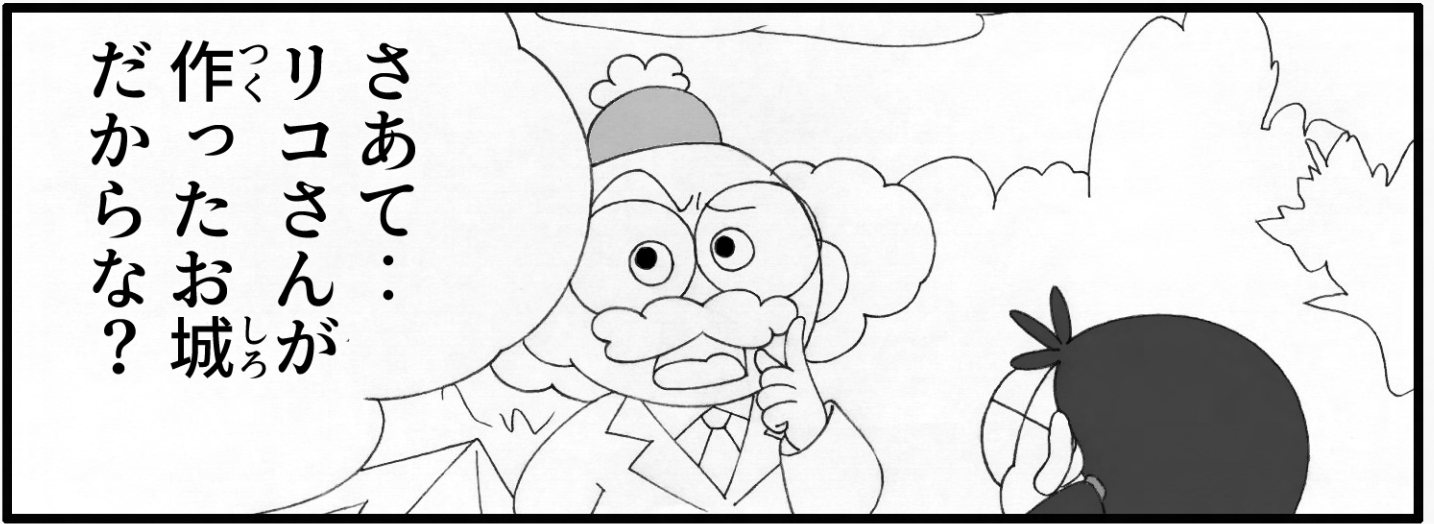

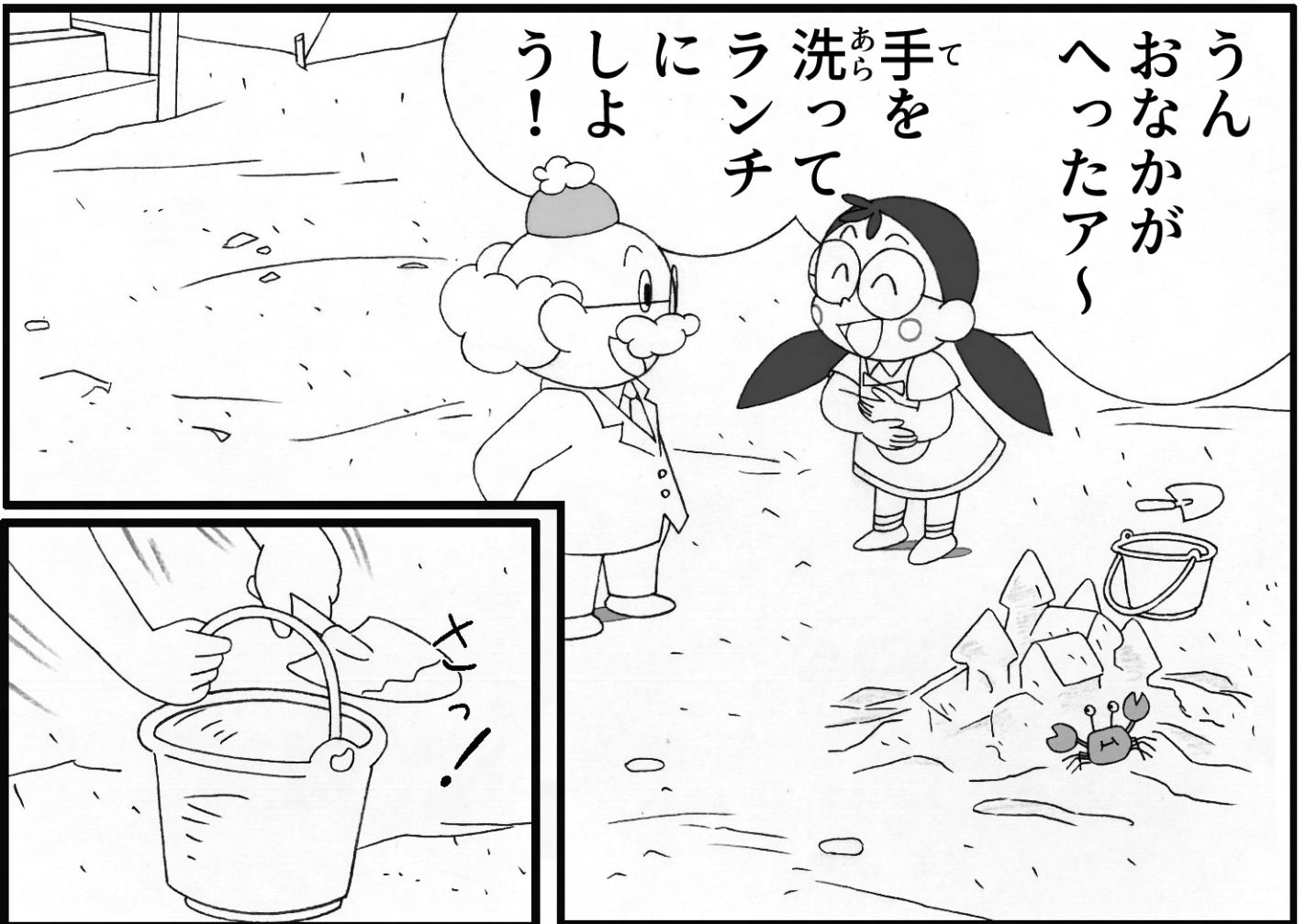
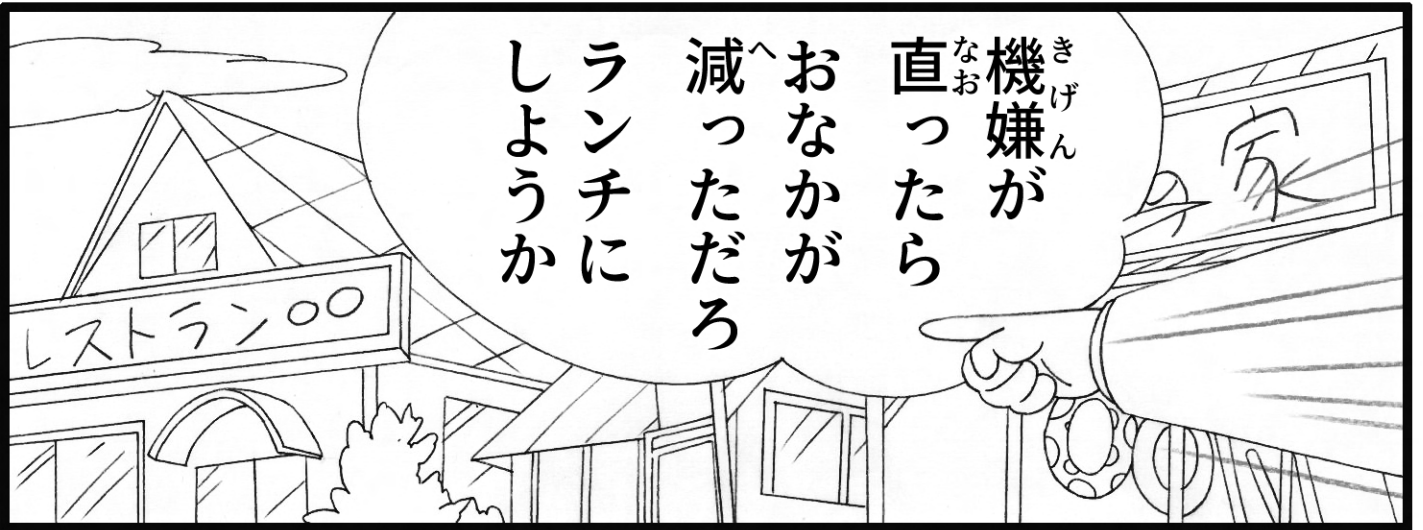

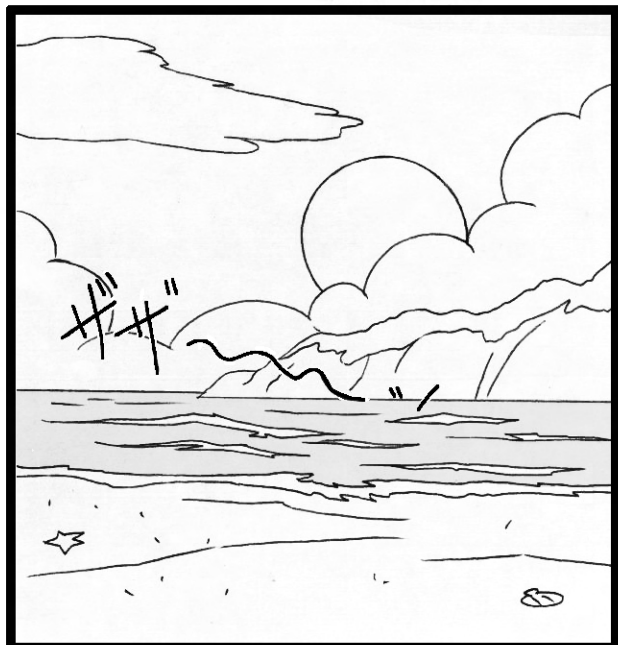
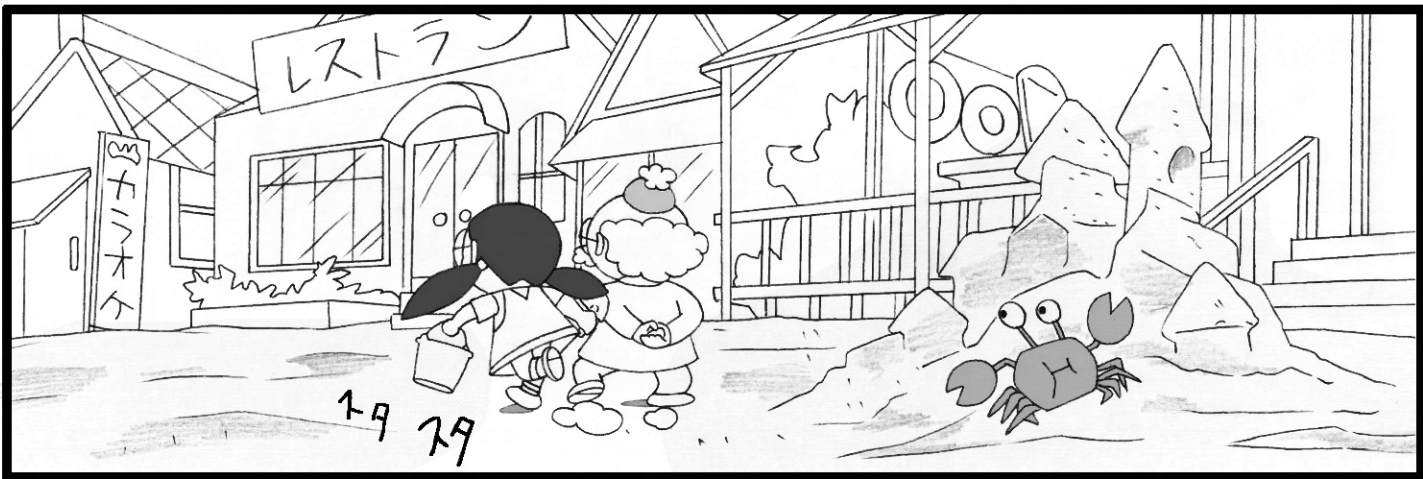

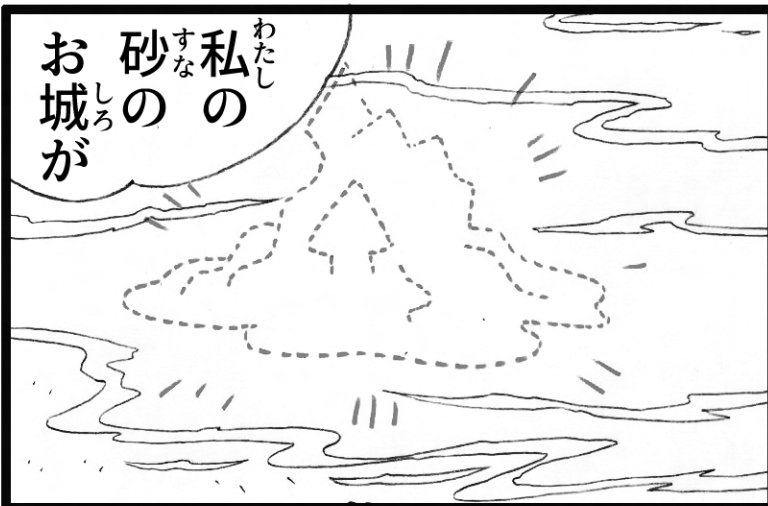

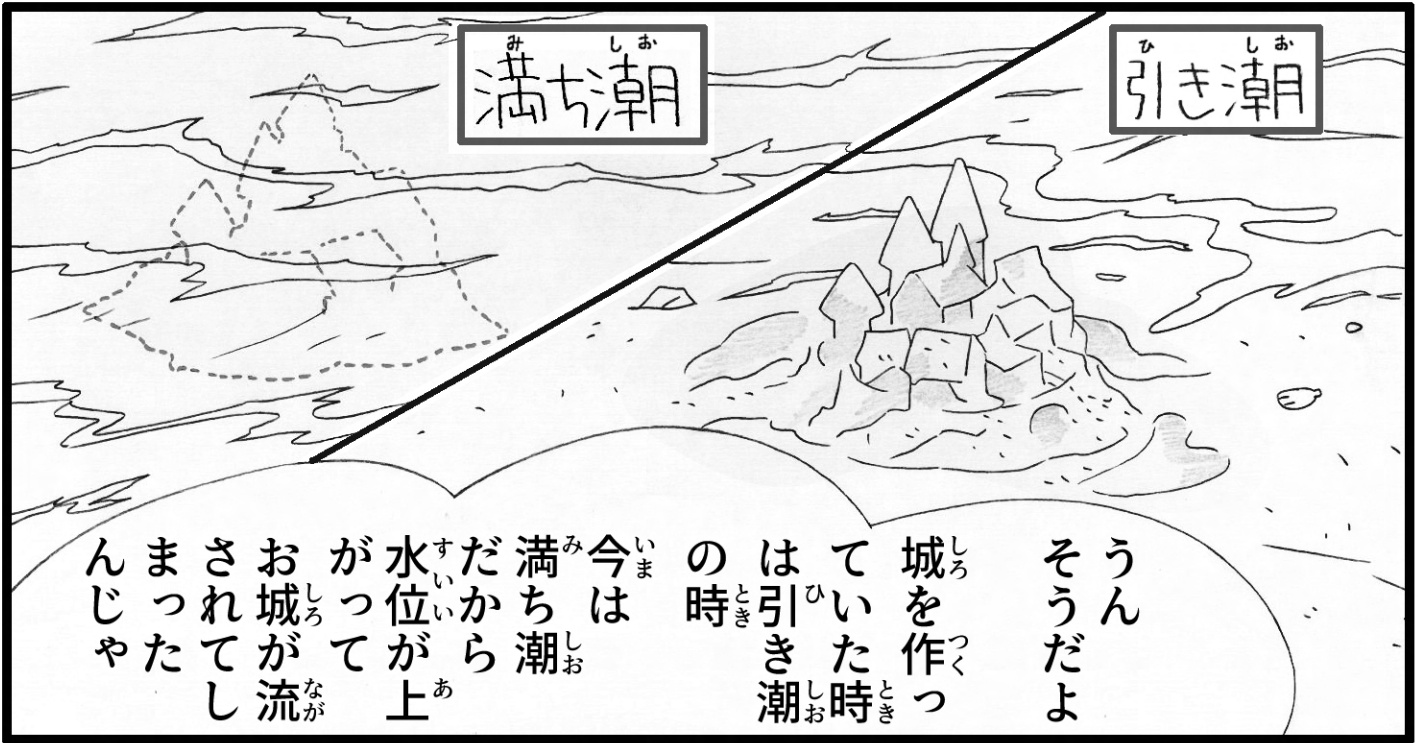

満ち潮

引き潮

うん そうだよ
 城を作った時
 ていた時
 は引き潮
 の時
 今は今
 満ち潮
 だから
 水位が上
 がって流
 お城が
 さらされて
 まった
 んじゃ



そうなん
 じゃ：



満ち潮？
 引き潮？

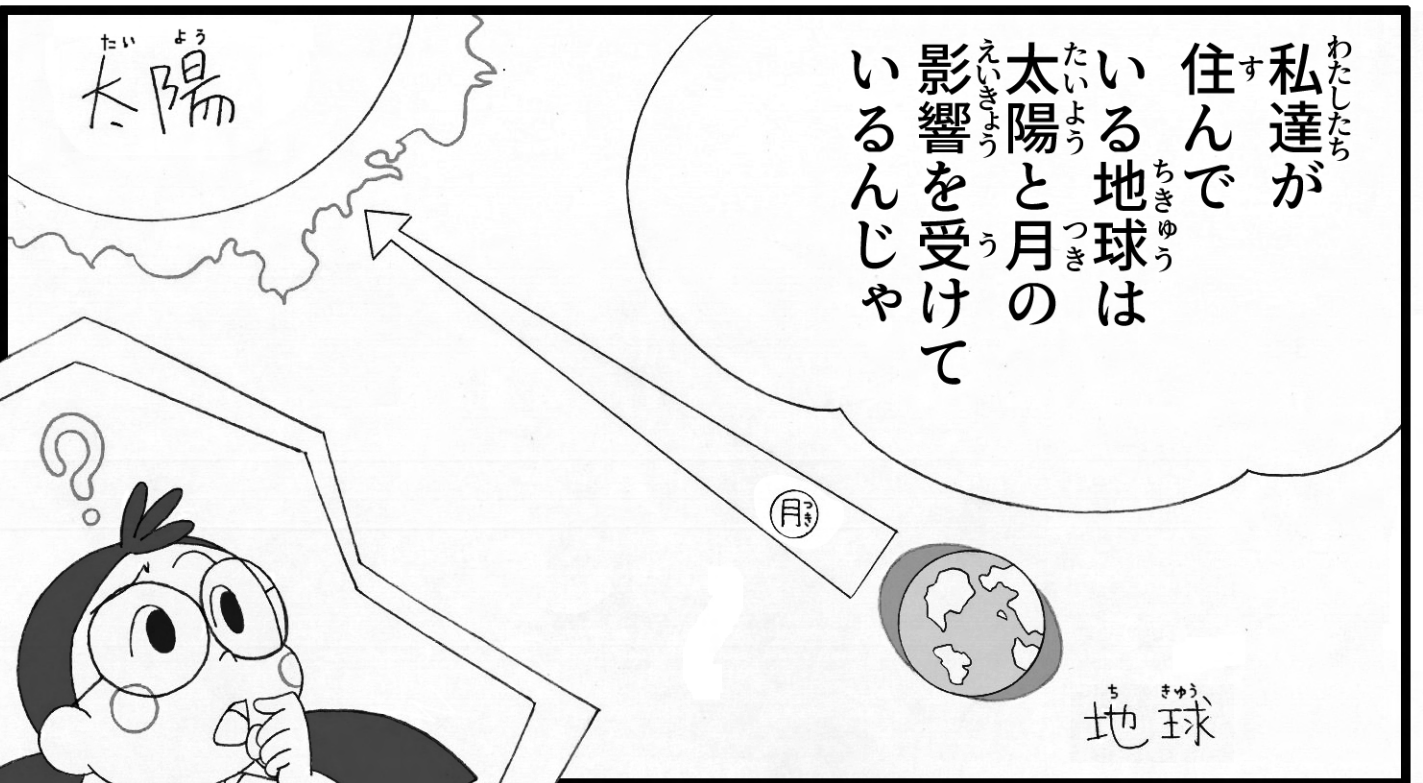

太陽

私達が
 住んで
 いる地球は
 太陽と月の
 影響を受けて
 いるんじや

地球



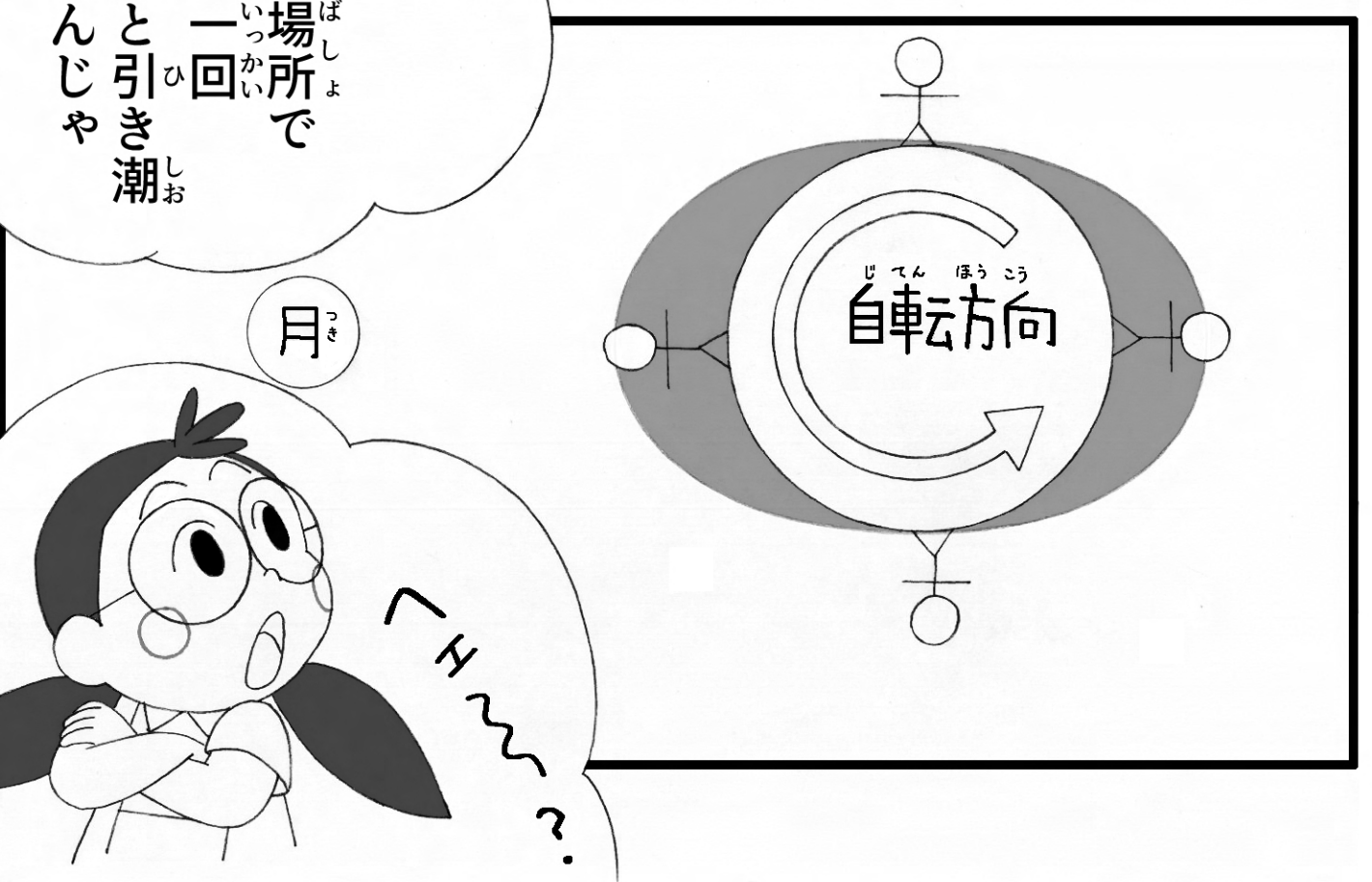
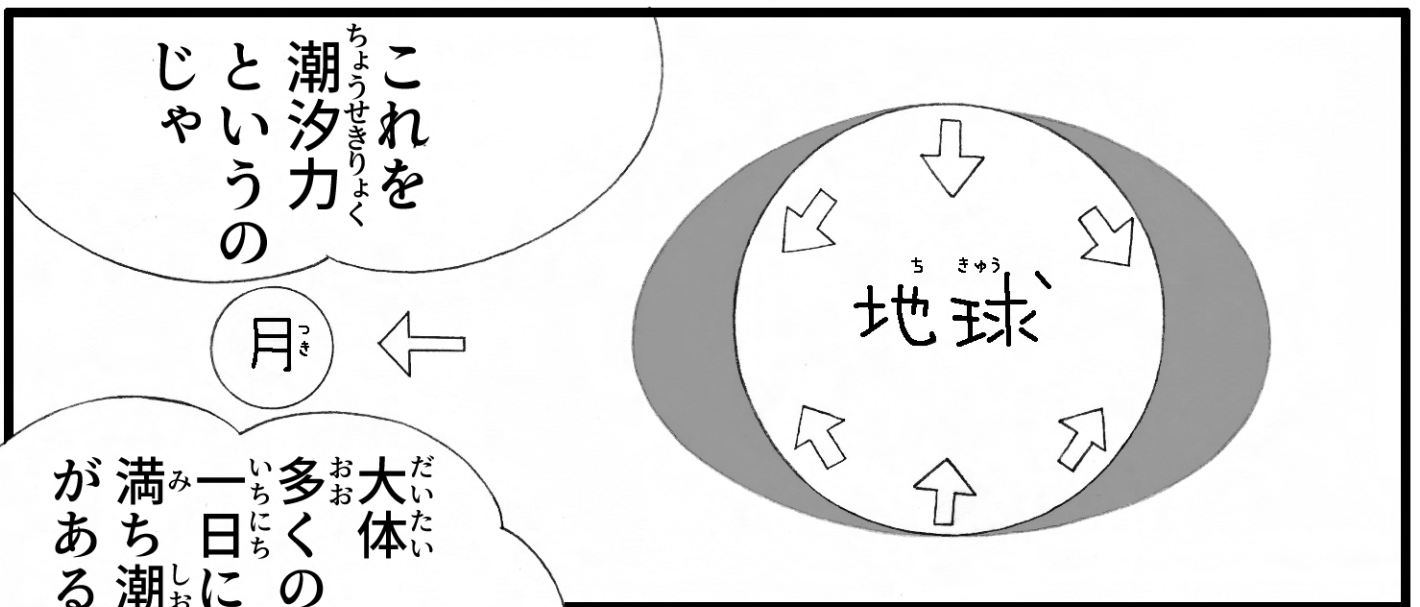
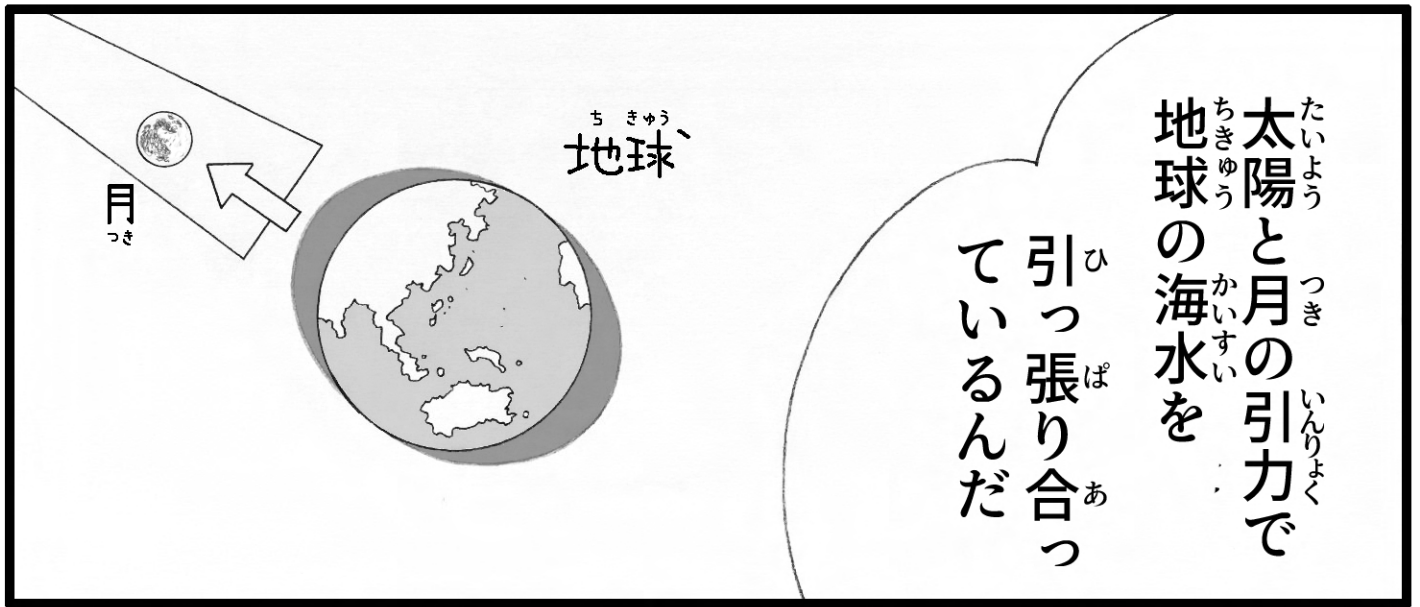



ねえ博士はかせ
さつき
カニさんたちが遊あそんで
いたで
しょ？



なん
で
何なんで
研究けんきゅう所じょ
なん
じゃ？



でね：
研究けんきゅう所じょで
カニさんを
作つくれない？



だっ
て
ほん
と
う
本
当
の
カ
ニ
さ
ん
達
は
か
い
す
い
海
水
が
な
無
い
と
こ
ま
困
る
で
し
よ
？

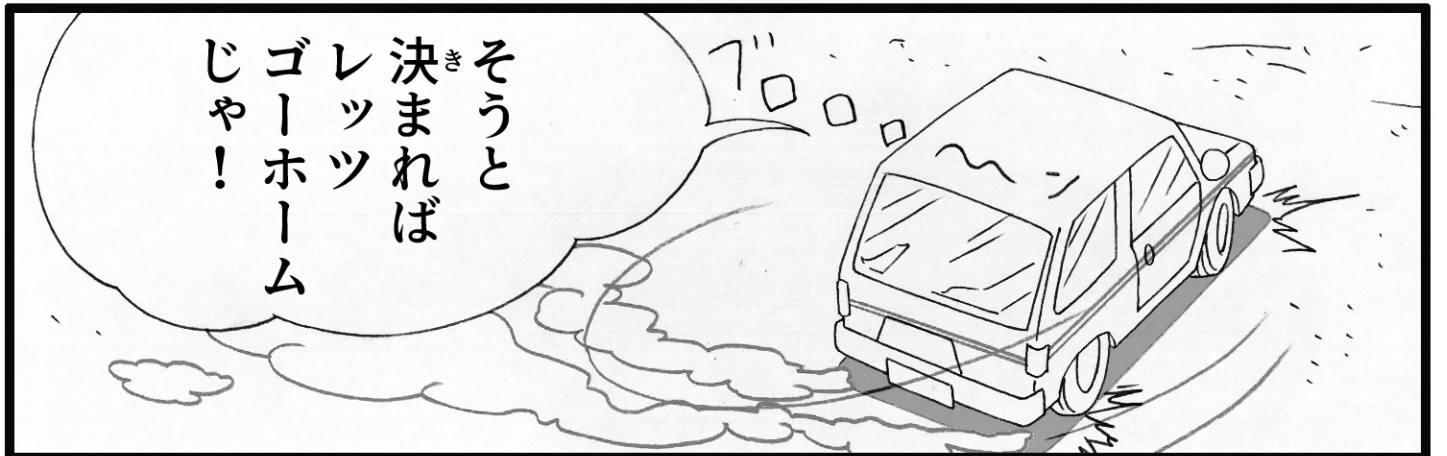
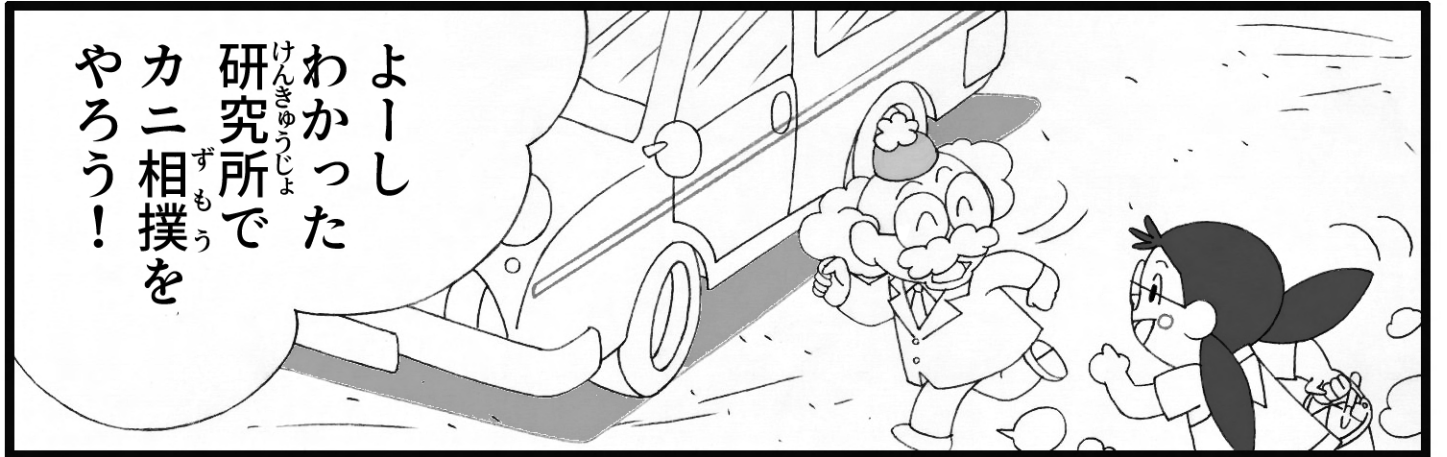

こうさくへん

カニずもう工作編

用意するもの

まずは
準備から
じゃ……

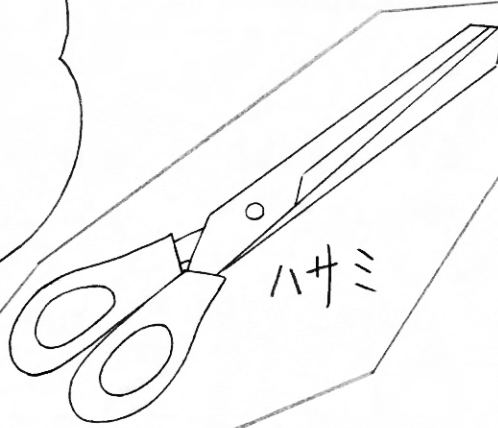

飲み終わった牛乳パック

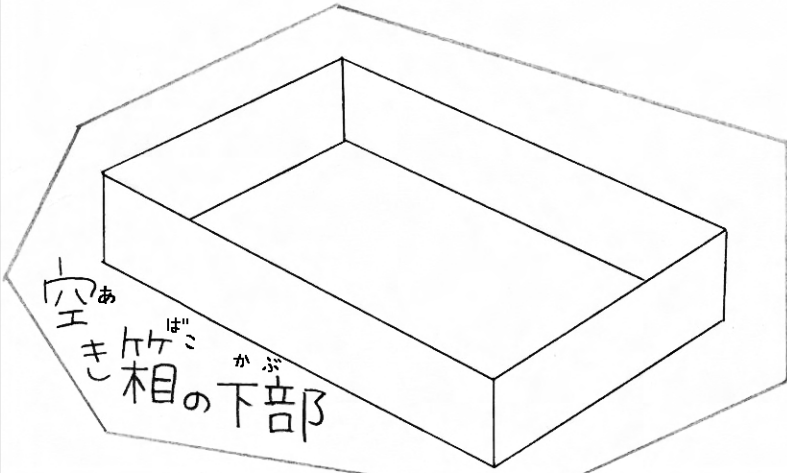

サインペン

4つの角にも切り込みを入れ

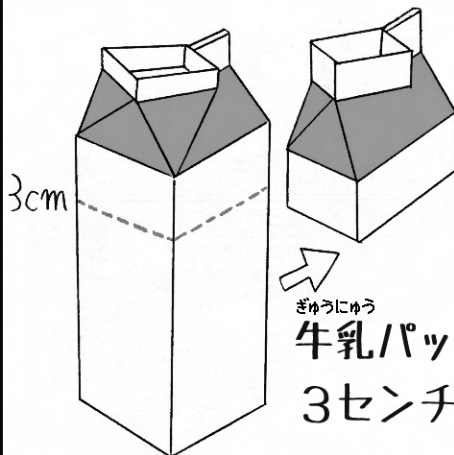
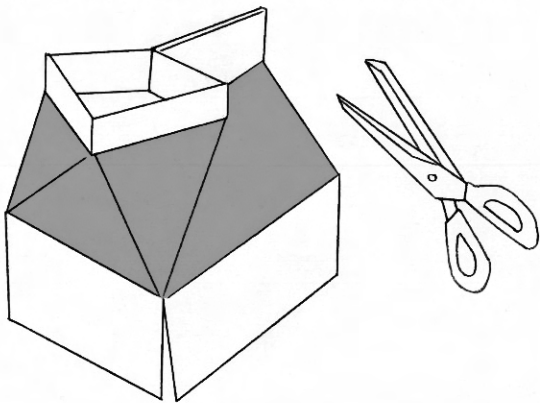

では
作りかた
方から
じゃ

牛乳パックの上部を
3センチくらいカットする

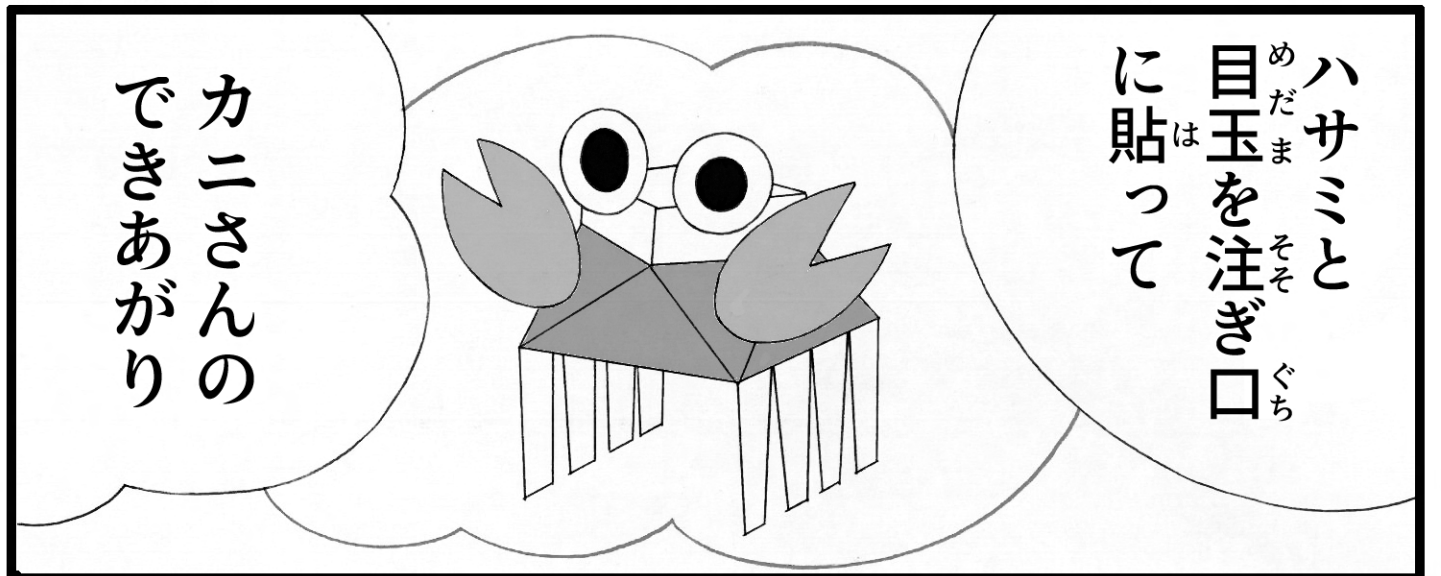
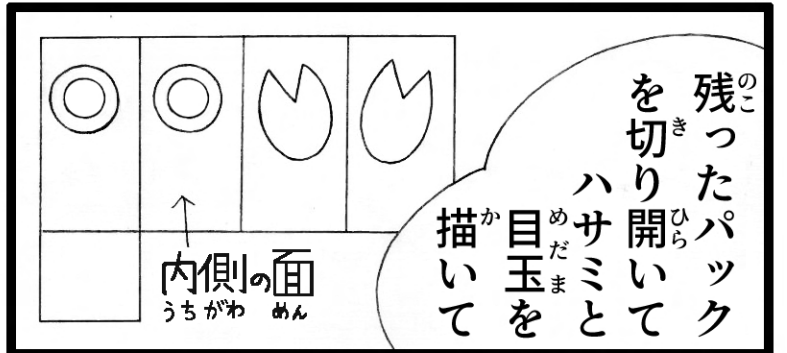
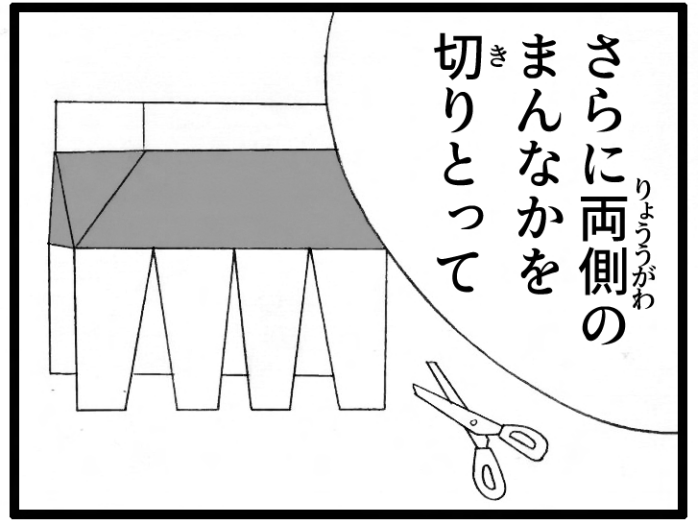
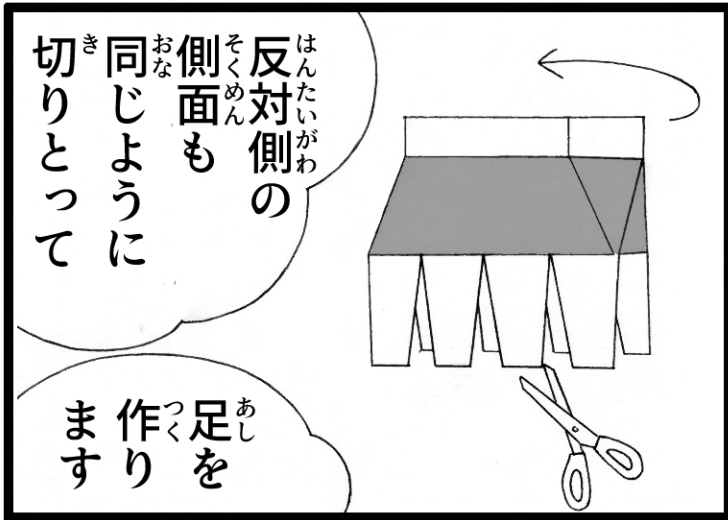
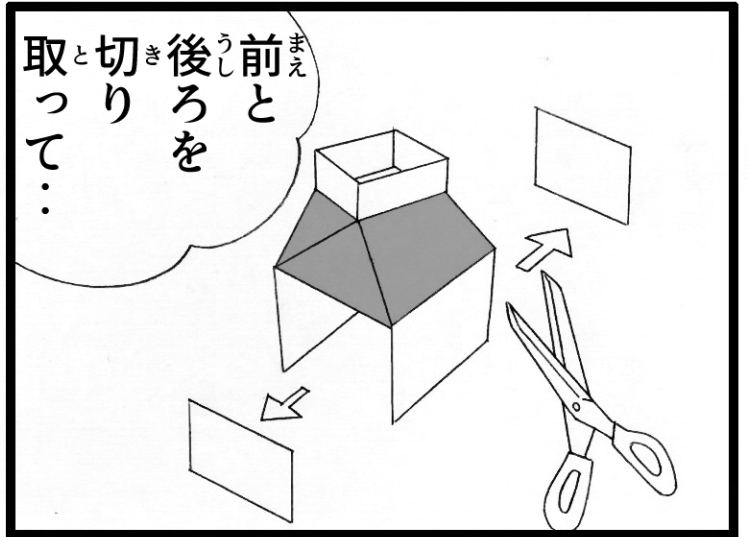
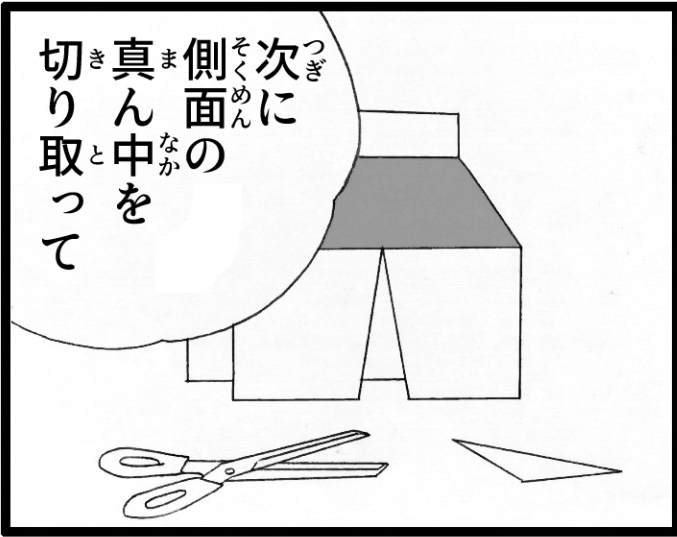

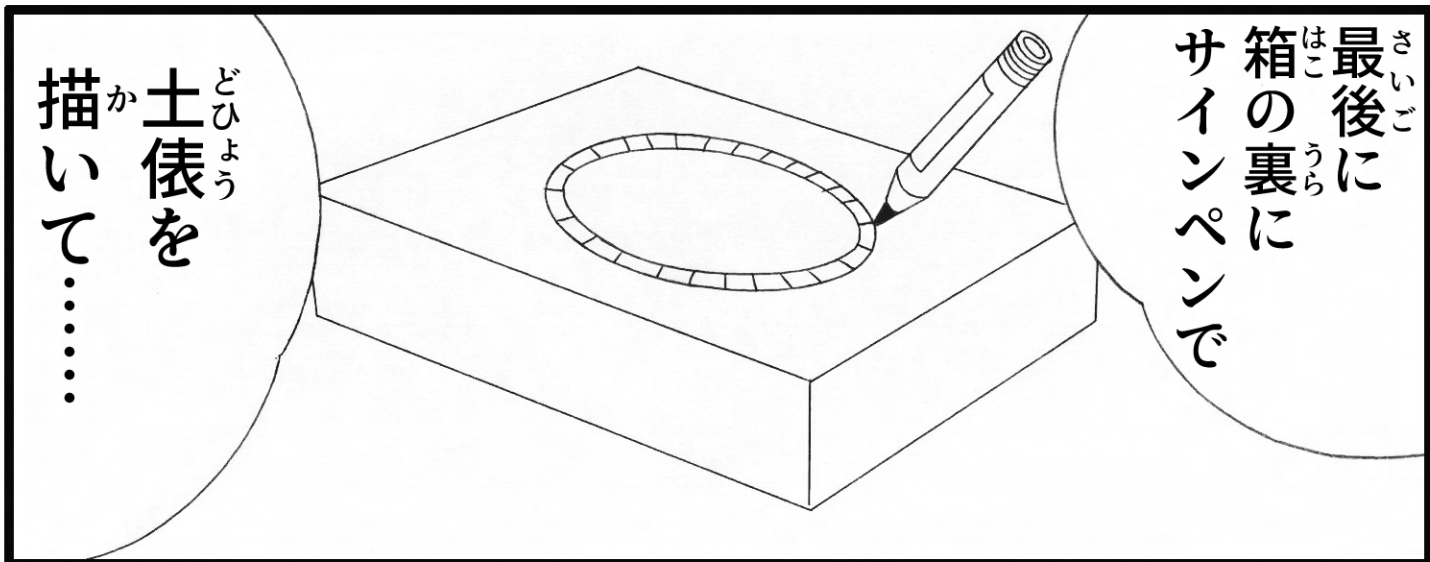

最後に
箱の裏に
サインペンで

どひよう
土俵を
か
描いて……

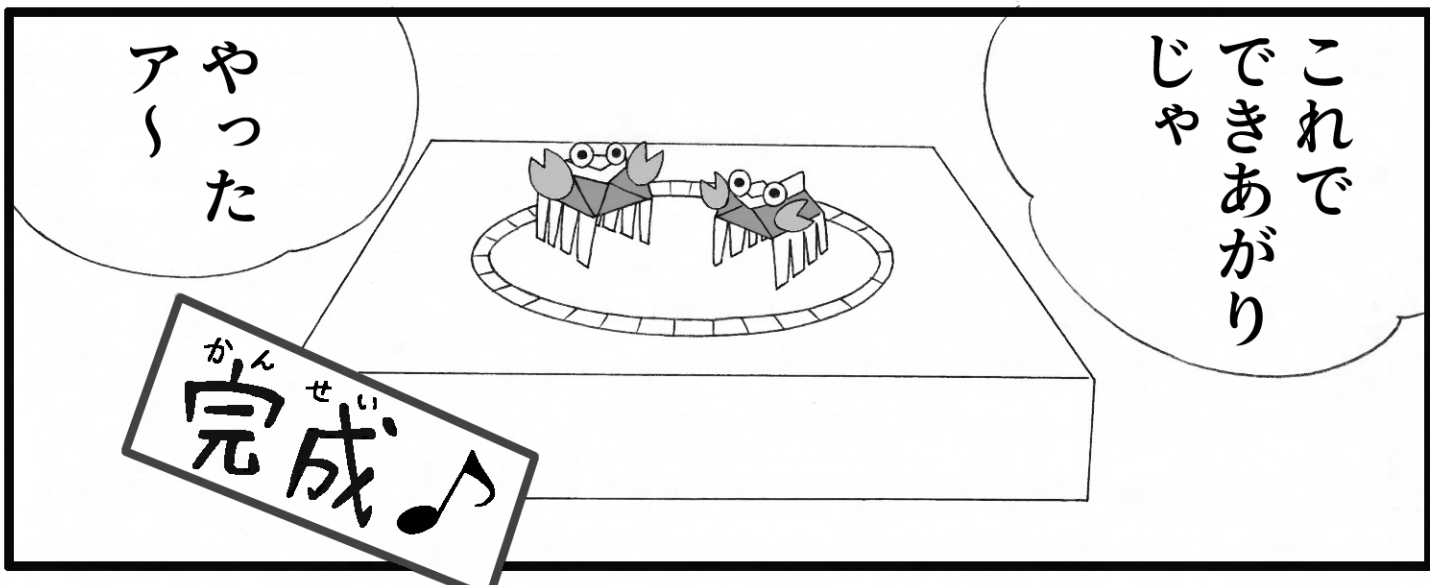

これで
できあがり
じゃ

やった
ア

かんせい
完成



それは
かんたん
簡単
じゃよ



博士
遊び方も
おし
教えて!

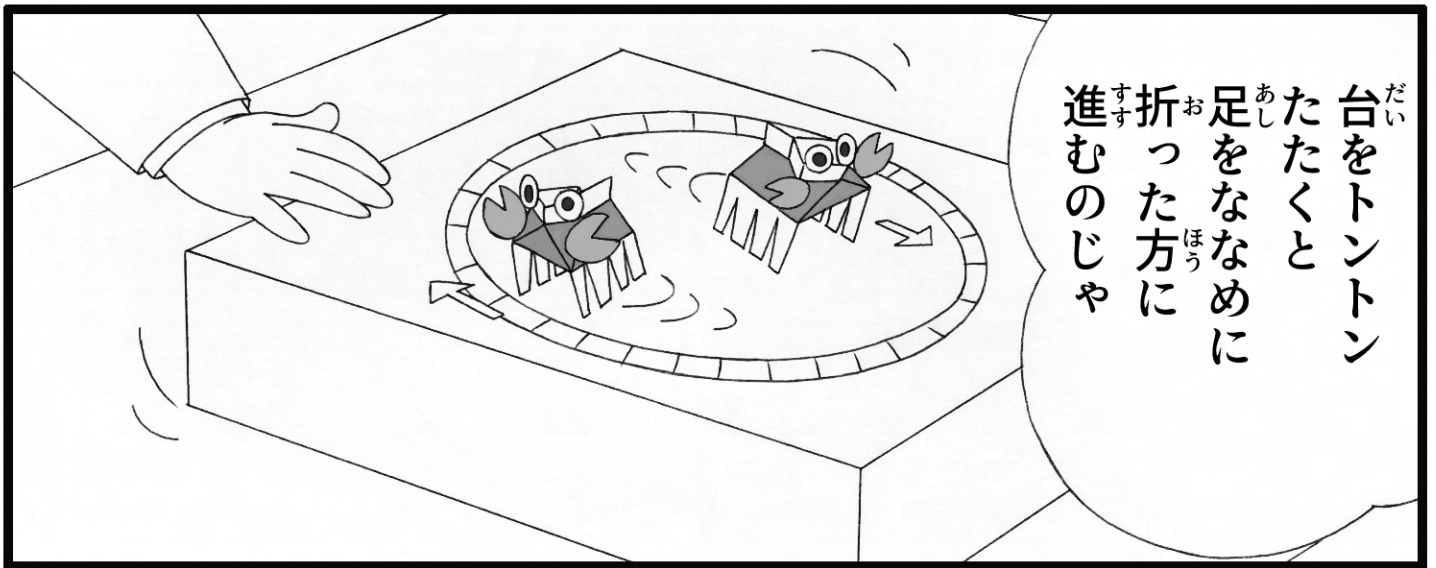

だい
台をトントン
たたくと
あし
足をななめに
お
折った方に
ほう
進むのじゃ



じゃみんなも
つく
作って
みて!



たの
楽しいぞ!
ともだち
これをお友達と
つく
作って遊んで
あそ
みしてくれ!